

CASQUE

LOGO
FFKAMA

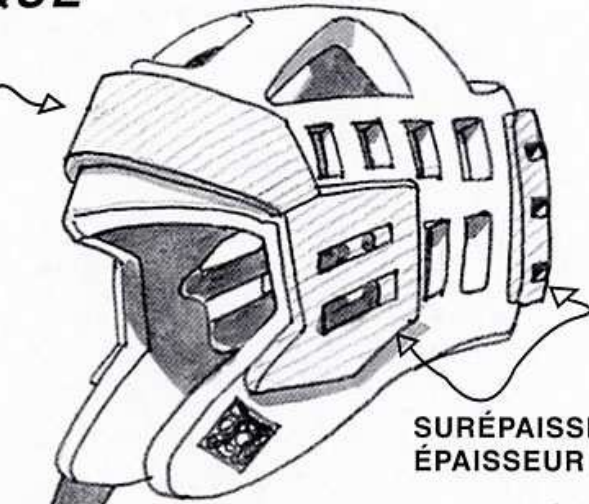

SURÉPAISSEUR DE 1 CENTIMÈTRE
ÉPAISSEUR DU CASQUE 2 + 1

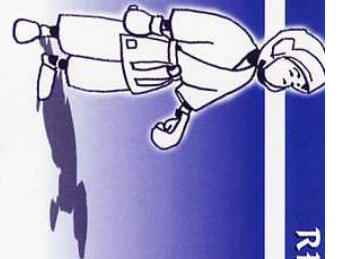
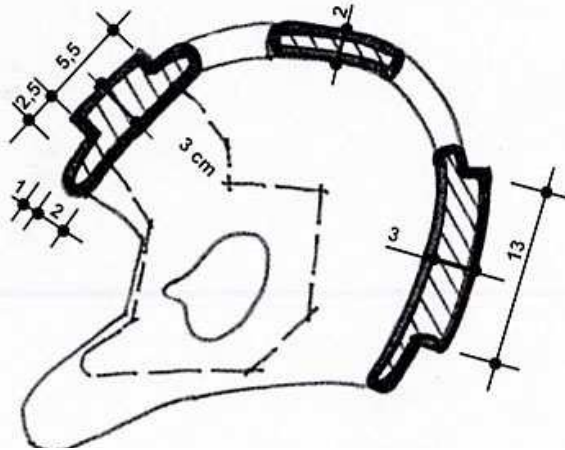

RÈGLEMENTATION COMPÉTITION 7

**Gants et casque
de compétition**

GANTS

Partie finie :

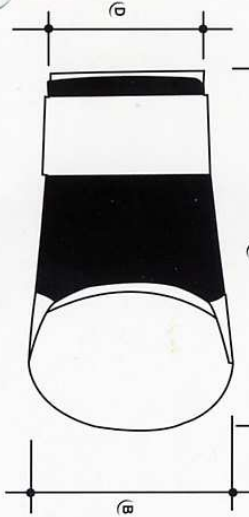
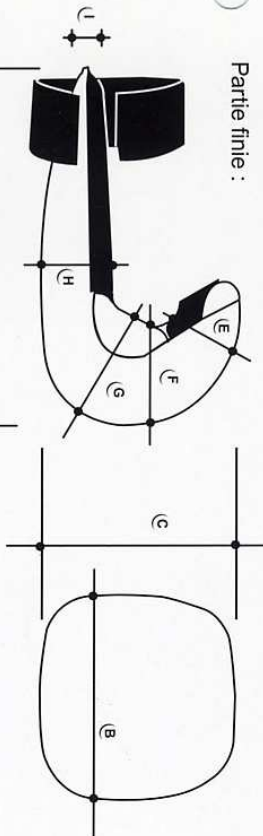

Dimensions en cm

	S	M	L	XL
A	14,2	16,2	19	20
B	8,5	9,5	10,5	11
C	10	11,5	11	11
D	7	8,5	8,5	9,5
E	3,5	4	3	3
F	6	6	6	6,5
G	5,5	6	6	6,5
H	3,5	4	4,5	4,5
I	1,5	1,5	2	2



Protège-pieds de compétition



Partie mousse compressée :

COUPE LONGITUDINALE :

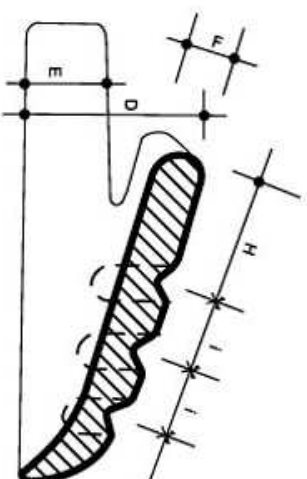

VUE EN PLAN :

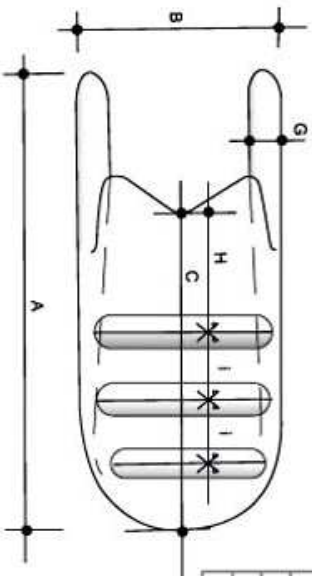

Cote en millimètres

	S	M	L	XL	XXL
A	210	215	230	245	260
B	100	105	110	115	115
C	138	157	170	180	220
D	70	75	85	90	95
E	35	35	40	43	45
F	20	20	30	30	30
G	13	15	15	18	20
H	40	55	55	65	65
I	33	35	40	43	45

Conception : *Bell*

CASQUE

LIGÈRE ET RIGIDE

	S	M	L	XL	XXL
A	5	5	5	5	5
B	2	2	2	2	2,5
C	4,5	5	5	5	6,5
D	2,5	3	3	3,5	3,5
E	1,5	1,5	1,5	1,5	1,5

SURTOUT ÉPAISSEUR DE 1 CENTIMÈTRE ÉPAISSEUR DU CASQUE 2 + 1

05	06	07	08	09	10	11	12	13	14	15
16	17	18	19	20	21	22	23	24	25	26
27	28	29	30	31	32	33	34	35	36	37
38	39	40	41	42	43	44	45	46	47	48
49	50	51	52	53	54	55	56	57	58	59
60	61	62	63	64	65	66	67	68	69	70
71	72	73	74	75	76	77	78	79	80	81
82	83	84	85	86	87	88	89	90	91	92
93	94	95	96	97	98	99	100			

revisión de 1978

